

32441 ✓ ACTIVE

PIDG

TE Internal #: 32441

Ring Terminals & Spade Terminals, Ring Tongue, 16 – 14 AWG

Wire Size, 1 – 2.5 mm<sup>2</sup> Wire Size, 2050 – 5180 CMA Wire Size, Stud

Size M2.5 / #4, PIDG

[View on TE.com >](#)



Terminals & Splices > Ring Terminals & Spade Terminals

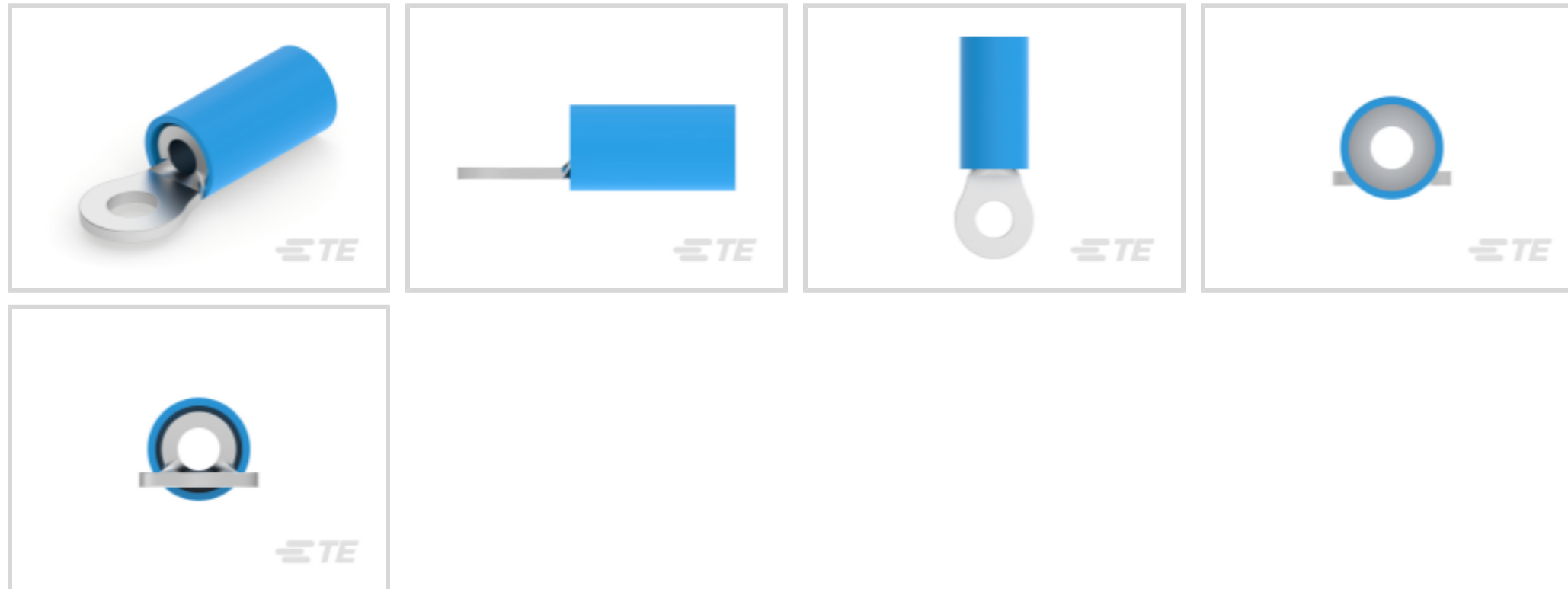

Ring & Spade Terminal Type: **Ring Tongue**

Wire Size: **2050 – 5180 CMA**

Stud Size: **#4, M2.5**

## Features

### Product Type Features

Shape Description	RING-041
Stud Size	#4, M2.5
Sealable	No
Wire Insulation Support Retention Type	Insulation Support

### Configuration Features

Number of Holes	1
Terminal Angle	180 °

### Electrical Characteristics

Voltage (Max)	300 V
---------------	-------

### Body Features

Inspection Slot	No
Insulation Sleeve Color	Blue
Weight per Piece	.94 g
Stripe Color	Blue

### Contact Features



Ring & Spade Terminal Type	Ring Tongue
Barrel Type	Closed
Terminal Orientation	Straight
Terminal Plating Material	Tin

### Mechanical Attachment

Wire Insulation Support	With
-------------------------	------

### Dimensions

Wire Size	2050 – 5180 CMA
Stud Diameter	3 mm[.118 in]
Tongue Thickness	1.02 mm[.04 in]
Overall Product Length	17.85 mm[.703 in]
Accepts Wire Insulation Diameter (Max)	4.32 mm[.17 in]
Accepts Wire Insulation Diameter Range	2.92 – 4.31 mm[.115 – .17 in]

### Usage Conditions

Insulation Option	Partially Insulated
Operating Temperature Range	105 °C[221 °F]

### Operation/Application

Compatible With Wire Base Material	Copper
Compatible With Wire Plating Material	Tin
Heavy Duty	No

### Industry Standards

Government Qualified	No
----------------------	----

### Packaging Features

Packaging Quantity	1000
Packaging Method	Bag

### Product Compliance

[For compliance documentation, visit the product page on TE.com>](#)

EU RoHS Directive 2011/65/EU	Compliant
EU ELV Directive 2000/53/EC	Compliant
China RoHS 2 Directive MIIT Order No 32, 2016	No Restricted Materials Above Threshold
EU REACH Regulation (EC) No. 1907/2006	



Current ECHA Candidate List: JUNE 2022  
(224)  
Candidate List Declared Against: JAN 2022  
(223)  
Does not contain REACH SVHC

Halogen Content Not Low Halogen - contains Br or Cl > 900 ppm.

Solder Process Capability Not applicable for solder process capability

**Product Compliance Disclaimer**

This information is provided based on reasonable inquiry of our suppliers and represents our current actual knowledge based on the information they provided. This information is subject to change. The part numbers that TE has identified as EU RoHS compliant have a maximum concentration of 0.1% by weight in homogenous materials for lead, hexavalent chromium, mercury, PBB, PBDE, DBP, BBP, DEHP, DIBP, and 0.01% for cadmium, or qualify for an exemption to these limits as defined in the Annexes of Directive 2011/65/EU (RoHS2). Finished electrical and electronic equipment products will be CE marked as required by Directive 2011/65/EU. Components may not be CE marked. Additionally, the part numbers that TE has identified as EU ELV compliant have a maximum concentration of 0.1% by weight in homogenous materials for lead, hexavalent chromium, and mercury, and 0.01% for cadmium, or qualify for an exemption to these limits as defined in the Annexes of Directive 2000/53/EC (ELV). Regarding the REACH Regulation, the information TE provides on SVHC in articles for this part number is based on the latest European Chemicals Agency (ECHA) 'Guidance on requirements for substances in articles' posted at this URL: <https://echa.europa.eu/guidance-documents/guidance-on-reach>

## Compatible Parts

TE Part # 59824-1  
TETRA-CRIMP PIDG PG FASTON 22-10 ASSY

TE Part # 58433-3  
PRO CR ASSY, RBY IS9252

TE Part # 59250  
T-HEAD PIDG 26-14 ASSY

TE Part # 47387  
DAHT PG PIDG 20-14 ASSY

TE Part # 58423-1  
DIE, RBY IS9252

TE Part # 525691  
DAHT PG PIDG 16-14 ASSY

TE Part # 539691-2  
ERGO DIE R.B.Y

TE Part # 2063030-1  
SDE DIESET, RBY, UL

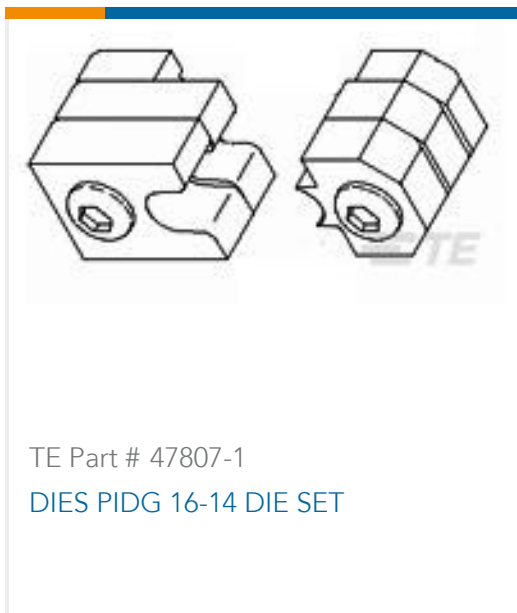

## Also in the Series | PIDG

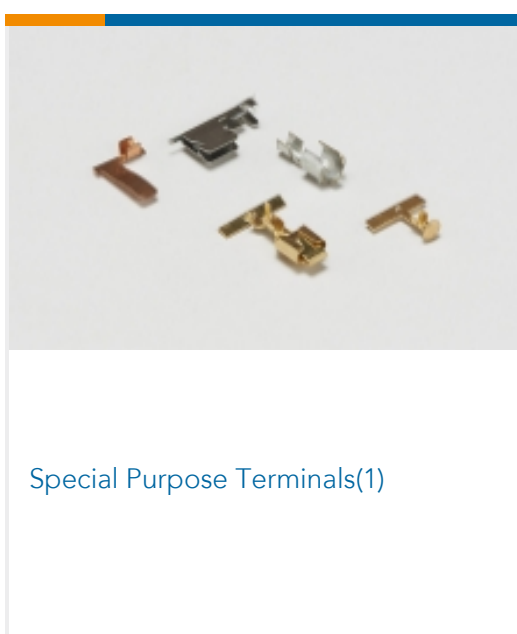
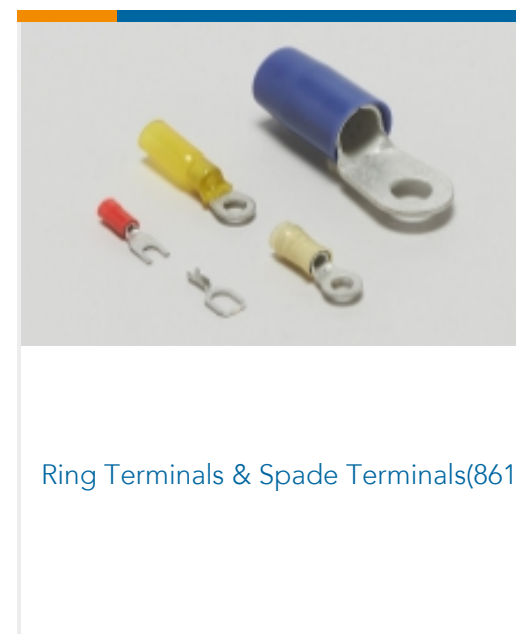
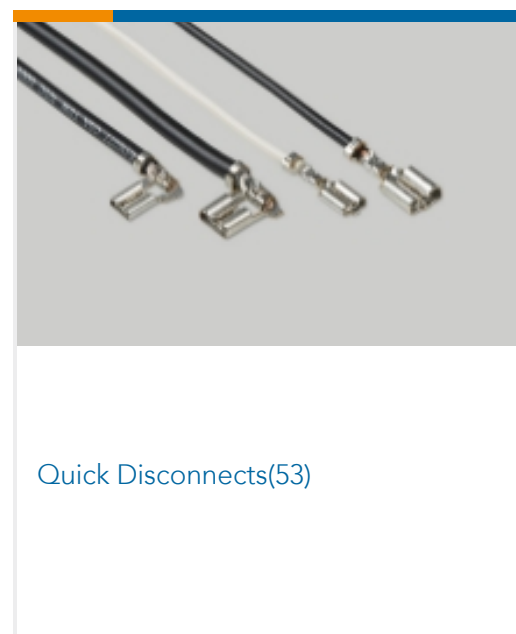
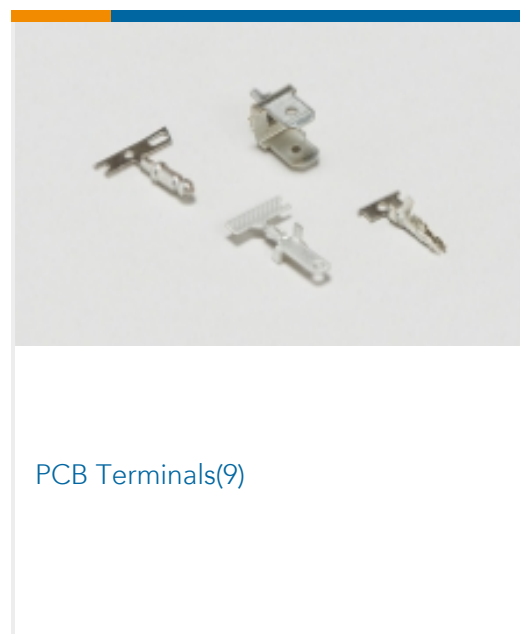
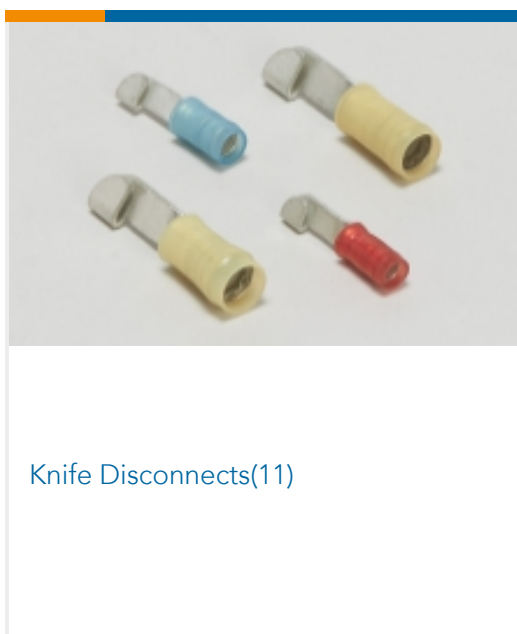
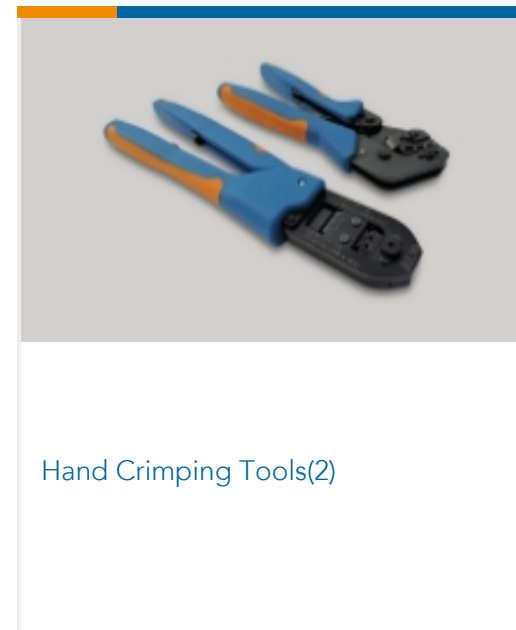
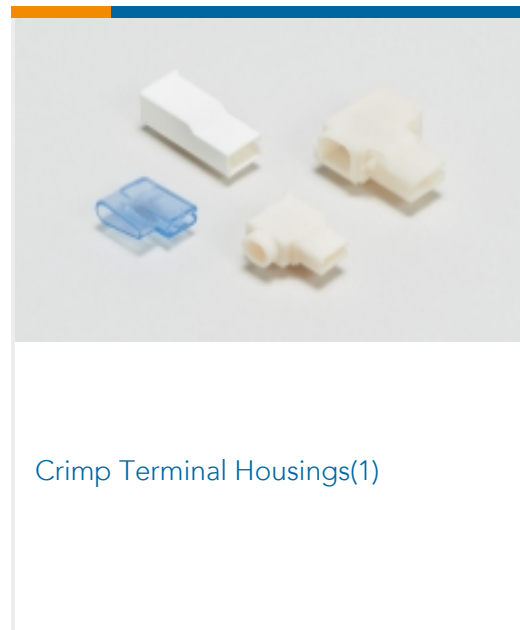
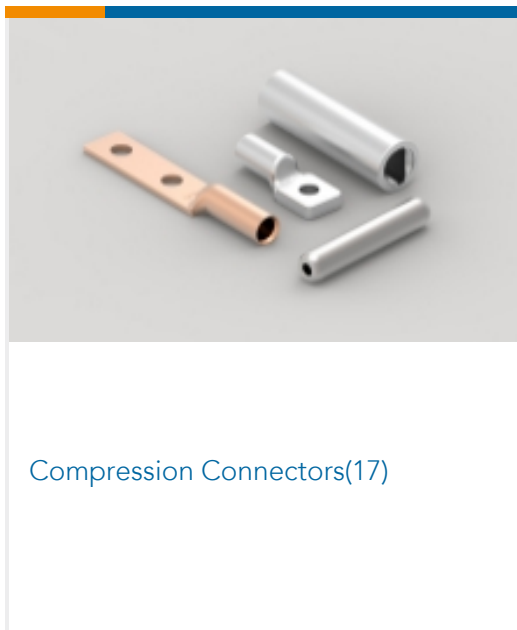

## Documents



**Product Drawings**

[TERMINAL,PIDG R 16-14 4](#)

English

---

**CAD Files**

Customer View Model

[ENG\\_CVM\\_CVM\\_32441\\_T.2d\\_dxf.zip](#)

English

**3D PDF**

3D

Customer View Model

[ENG\\_CVM\\_CVM\\_32441\\_T.3d\\_igs.zip](#)

English

Customer View Model

[ENG\\_CVM\\_CVM\\_32441\\_T.3d\\_stp.zip](#)

English

By downloading the CAD file I accept and agree to the [Terms and Conditions](#) of use.

---

**Product Specifications**

[Application Specification](#)

English

---

**Agency Approvals**

[UL Report](#)

English

[UL Report](#)

English